

MAX48N-12A10K40600

MAX®

LINEAR ENCODERS

SICK
Sensor Intelligence.



Illustration may differ

Ordering information

Type	Part no.
MAX48N-12A10K40600	1219733

Accessories not included with delivery, please order separately.

Other models and accessories → www.sick.com/MAX



Detailed technical data

Features

Items supplied	Accessories not included with delivery, please order separately.
-----------------------	--

Performance

Type	48 mm installation housing – IN cylinder mounting
Cable connection	Radial
Pressure pipe/End cap	Flat/M6 threaded stud
Measured values	Positioning
Measuring range	Position (F.S.) 0 mm ... 600 mm ¹⁾
Unusable range	Null zone 30 mm Damping zone 30 mm
Switch-on time	< 250 ms
Measuring frequency (internal)	2 ms
Transmission rate (cycle time)	Steady signal
Setpoint tolerance	Zero point and F.S. $\leq \pm 1$ mm
Resolution	Typ. 0.1 mm (noise-free)
Hysteresis	$\pm 0,1$ mm
Repeatability	Typ. ± 0.2 mm
Linearity (in the operational status)	Typ. ± 0.25 mm (measuring range 50 to 500 mm) ²⁾ Typ. $\pm 0.04\%$ F.S. (measuring range from 500 to 2,500 mm)
Temperature drift	Warming up phase Typ. $\leq \pm 0.25$ mm (2 min) In the operational status Typ. $\leq \pm 0.005\% \times \text{F.S.} \times \Delta T$ (ΔT 40 °C) ³⁾

¹⁾ F.S. = Full Scale (Measuring range).

²⁾ Hydraulic oil at operating temperature.

³⁾ 40 °C increase in oil temperature during operation.

⁴⁾ This product is a standard product and does not constitute a safety component as defined in the Machinery Directive. Calculation based on nominal load of components, average ambient temperature of electronic 60 °C, frequency of use 8760 h/a.

⁵⁾ Every second failure of an electronic component is regarded as a dangerous failure.

MTTFd	69 years (EN ISO 13849-1) ^{4) 5)}
--------------	--

1) F.S. = Full Scale (Measuring range).

2) Hydraulic oil at operating temperature.

3) 40 °C increase in oil temperature during operation.

4) This product is a standard product and does not constitute a safety component as defined in the Machinery Directive. Calculation based on nominal load of components, average ambient temperature of electronic 60 °C, frequency of use 8760 h/a.

5) Every second failure of an electronic component is regarded as a dangerous failure.

Interfaces

Communication interface	Analog
Communication Interface detail	Current
Current output	4 mA ... 20 mA

Electrical data

Connection type	Connecting cable, 3-wire
Supply voltage	24 V DC (8 ... 32 V DC)
Residual ripple	< 1% S-S
Power consumption	≤ 1.25 W
Current consumption	≤ 50 mA
Load resistance	
Current signal	100 Ω ≤ RL ≤ 500 Ω
Switch-on current	Typ. 5.0 A / 50 μs
Over voltage protection	≤ 36 V at all poles during power-up (60 s) ≤ 48 V To GND during power-up (60 s)
Reverse polarity protection	≤ 36 V (at all poles) (ISO 16750-2)
Insulation resistance	Riso ≥ 10 MΩ, 60 s (ISO 16750-2)
Dielectric strength	500 V DC, 0 V against housing (ISO 16750-2)

Mechanical data

Dimensions		
Housing	48 mm, 48f7 for IN cylinder mounting – cylinder bore hole 48H8	
Ø pressure pipe	10 mm	
Ø O-ring	40.87 mm x 3.53 mm	
Ø support ring	42.6 mm x 48 mm x 1.4 mm	
Ø connecting cable	Ø 5.0 mm; 3 x 0.38 mm ² (AWG22), stripped	
Length of cable	1,000 mm	
Material		
Housing	Stainless steel 1.4305, AISI 303	
Pressure pipe	Stainless steel 1.4404, AISI 316L	
Housing cover	Plastic	
O-ring	NBR 70	
Support ring	PTFE	
Connecting cable	PUR	

Ambient data

EMC	EU Directive 2014/30 / EU CE marking
Generic standards	According to EN 61000-6-2:2005 and EN 61000-6-3:2007
Agricultural and forestry machinery Construction machinery	EN ISO 14982:2009 / EN 13309:2010 / EN ISO 13766-1:2018
Transient pulses	ISO 7637-2
ESD (air and contact discharge)	EN 61000-4-2 ISO/TR 10605
Enclosure rating	
Housing with connecting cable	IP67 (EN 60529)
Temperature	
Operating temperature range (electronics)	-40 °C ... +105 °C ¹⁾
Ambient temperature (fluid)	-30 °C ... +95 °C ²⁾
Storage temperature range	-20 °C ... +65 °C ^{3) 4)}
Permissible relative humidity	90 % (Condensation not permitted)
Resistance to shocks	Drop test in acc. with IEC 60068-2-31 100 g, 11 ms (Single shock in acc. with IEC 60068-2-27) 50 g, 11 ms (Continuous shocks, 1,000 shocks per spatial axis in acc. with IEC 60068-2-27)
Resistance to vibration	
Sine	20 g, 24 h / spatial axis, 55 ... 2.000 Hz (IEC 60068-2-6)
Sine over noise	18 g (r.m.s), 36 h / spatial axis, 10 ... 2.000 Hz (IEC 60068-2-80)
Broadband noise (resonance peaks removed)	20 g (r.m.s), 48 h / spatial axis, 10 ... 2.000 Hz (IEC 60068-2-64)
Nominal operating pressure (P_N)	400 bar
Max. overload pressure during operation (P_N x 1.2)	480 bar
Max. test pressure in cylinder (P_N x 1.5)	600 bar
Note	For details of applied tests and descriptive standards, please see document 8021473

¹⁾ Taking into account self-heating, generated through constant electrical operation with supply voltage.

²⁾ Caused by the permitted temperature range of the O-ring seal, the hydraulic oil and the temperature-dependent signal quality of the position magnet.

³⁾ Relative humidity 55 %.

⁴⁾ Caused by dry storage of the O-ring in uninstalled state (no coating with oil).

Classifications

ECl@ss 5.0	27270705
ECl@ss 5.1.4	27270705
ECl@ss 6.0	27270705
ECl@ss 6.2	27270705
ECl@ss 7.0	27270705
ECl@ss 8.0	27270705
ECl@ss 8.1	27270705
ECl@ss 9.0	27270705
ECl@ss 10.0	27270705
ECl@ss 11.0	27270705
ETIM 5.0	EC002544
ETIM 6.0	EC002544

ETIM 7.0	EC002544
ETIM 8.0	EC002544
UNSPSC 16.0901	41111613

Dimensional drawing (Dimensions in mm (inch))

MAX48

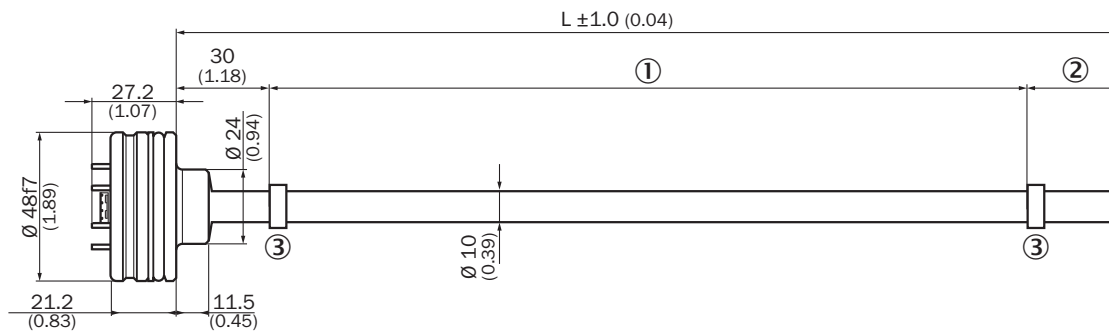

- ① Measuring range
- ② Damping zone
- ③ Position magnet

Cable, 3-wire

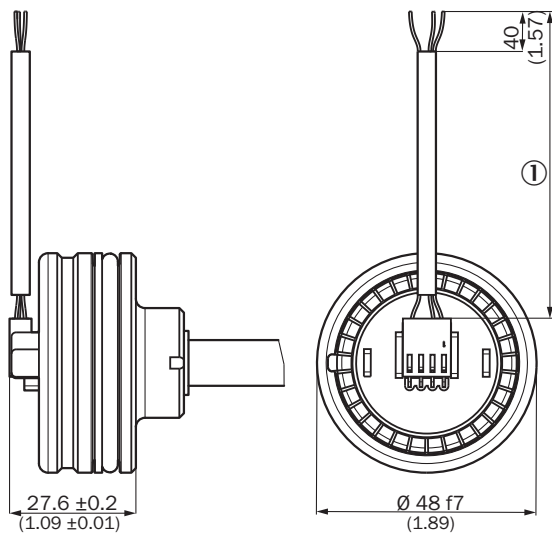

- ① Length of cable (according to type code)

Installation of position magnet

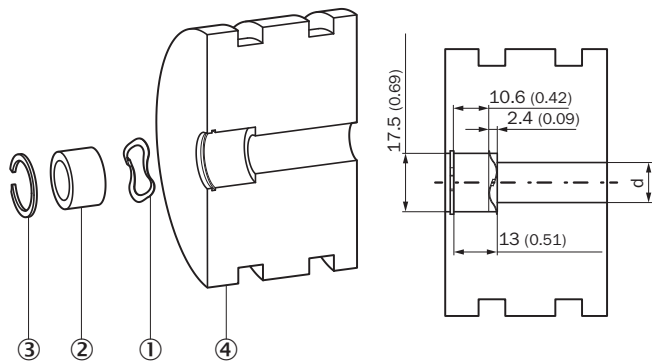

- ① Corrugated spring washer
- ② Position magnet
- ③ Circlip
- ④ Piston

Position magnet

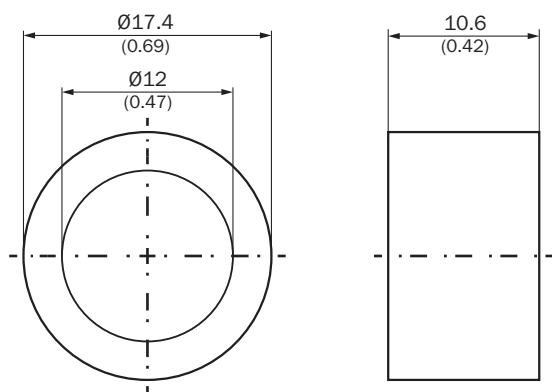

Circlip

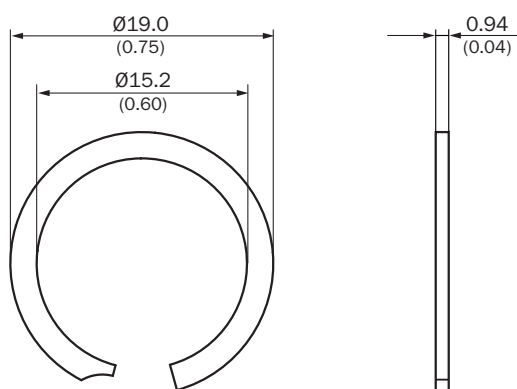

Corrugated spring washer

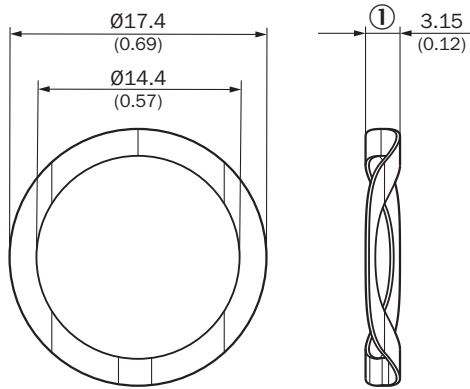

① Free height

Attachment specifications

Installation space for cylinders

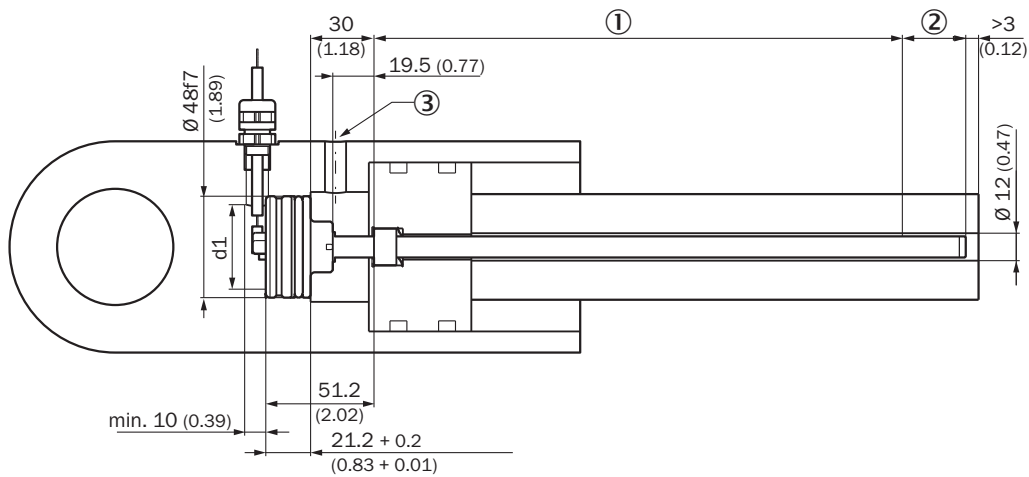

Please note the information in the operating instructions ($d: 32 \leq d1 \leq 40$).

- ① Measuring range
- ② Damping zone
- ③ Hydraulic port

PIN assignment

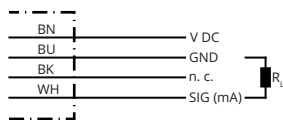

Connection diagram

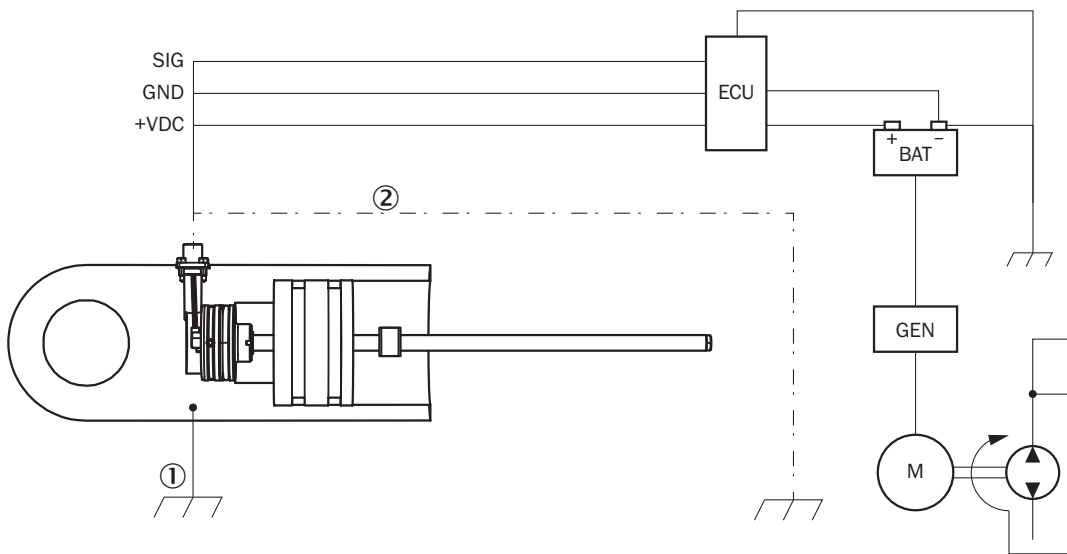

Connection diagram

- ① Chassis GND
- ② Cable shielding (optional)

Recommended accessories

Other models and accessories → www.sick.com/MAX

	Brief description	Type	Part no.
Magnets			
	Position magnet for magnetostrictive linear encoder, Ø 17.4 mm, max. axial surface pressure 40 N/mm ² , temperature range -30 °C ... +95 °C	MAG-O-174-01	2112714
		MAG-O-174-05	2112713
		MAG-O-174-10	2115045
		MAG-O-174-50	2112711
Other mounting accessories			
	1 piece, Circlip for installing the position magnets in the piston of the hydraulic cylinder, Stainless steel 1.4319	BEF-MK-SR-01	2116437
	5 pieces, Circlip for installing the position magnets in the piston of the hydraulic cylinder, Stainless steel 1.4319	BEF-MK-SR-05	2116438
	10 pieces, Circlip for installing the position magnets in the piston of the hydraulic cylinder, Stainless steel 1.4319	BEF-MK-SR-10	2116439
	50 pieces, Circlip for installing the position magnets in the piston of the hydraulic cylinder, Stainless steel 1.4319	BEF-MK-SR-50	2116440
	1 piece, Corrugated spring washer for installing the position magnets in the piston of the hydraulic cylinder, 1.4568 (17-7 PH Condition CH900)	BEF-MK-WF-01	2116431
	5 pieces, Corrugated spring washer for installing the position magnets in the piston of the hydraulic cylinder, 1.4568 (17-7 PH Condition CH900)	BEF-MK-WF-05	2116432
	10 pieces, Corrugated spring washer for installing the position magnets in the piston of the hydraulic cylinder, 1.4568 (17-7 PH Condition CH900)	BEF-MK-WF-10	2116433
	50 pieces, Corrugated spring washer for installing the position magnets in the piston of the hydraulic cylinder, 1.4568 (17-7 PH Condition CH900)	BEF-MK-WF-50	2116435

	Brief description	Type	Part no.
Plug connectors and cables			
	Head A: M12	BEF-EA-M12-S	2117513

SICK AT A GLANCE

SICK is one of the leading manufacturers of intelligent sensors and sensor solutions for industrial applications. A unique range of products and services creates the perfect basis for controlling processes securely and efficiently, protecting individuals from accidents and preventing damage to the environment.

We have extensive experience in a wide range of industries and understand their processes and requirements. With intelligent sensors, we can deliver exactly what our customers need. In application centers in Europe, Asia and North America, system solutions are tested and optimized in accordance with customer specifications. All this makes us a reliable supplier and development partner.

Comprehensive services complete our offering: SICK LifeTime Services provide support throughout the machine life cycle and ensure safety and productivity.

For us, that is “Sensor Intelligence.”

WORLDWIDE PRESENCE:

Contacts and other locations –www.sick.com