

5-year warranty

**Technical data**

<b>Functional data</b>	Fluid Temp Range (water)	Please Refer to Manufacturer's Valve Specifications
	Mounting Position	360°
	Applicable valve size	2" [50]
<b>Materials</b>	Hardware	zinc plated steel
	Spindle	stainless steel
	Frame, plate, base	stainless steel
	Coupling	stainless steel
<b>Suitable actuators</b>	Non-Spring	AMB(X) GMB(X)
	Spring	AF

For close-off pressure reference Select Pro or retrofit technical documentation.

**Product features**

- Default/Configuration** The actuator is sold separately from the linkage. This allows users to select any actuator with the desired control signal. Since the linkage utilises standard airside actuators, they can be purchased at any time and mounted in the field.
- Application** The UFLK/UBLK retrofit kit is designed to easily attach to the valve mounting pad on select competitor butterfly valves utilizing Belimo actuators.  
This kit will help to restore service without removal of the valve, saving down time. The retrofit kit is available in various configurations for use with both 2-way and 3-way valves utilizing single or dual actuation where applicable.
- Operation** The UFLK/UBLK kit and mounted actuator(s) are capable of rotating 95° in both CW and CCW directions. This allows the disc/ball to fully open or close. When directional needs vary, the actuators can be flipped or directional switch turned to a new rotation. Refer to the actuator wiring guides on Master/Slave wiring for dual mounted actuators.

Dimensions

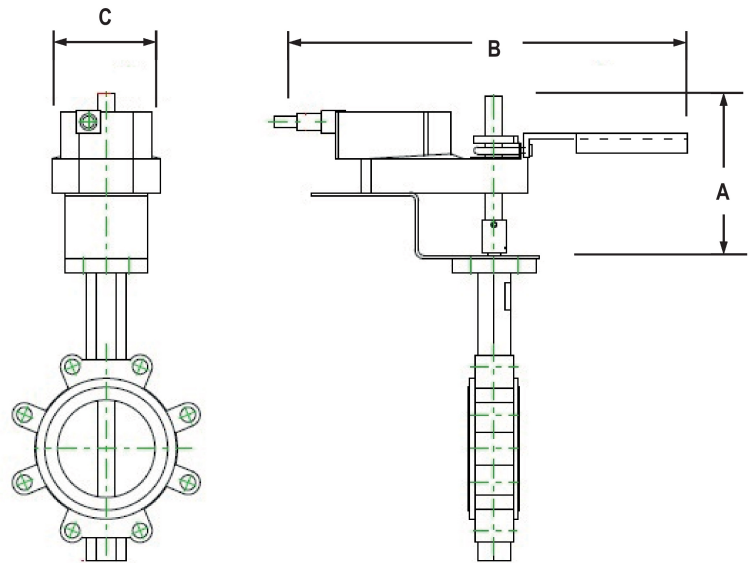

AMB, AMX, GKB, GKX, GMB, GMX

A	B	C
7.0" [178]	14.0" [356]	6.9" [175]

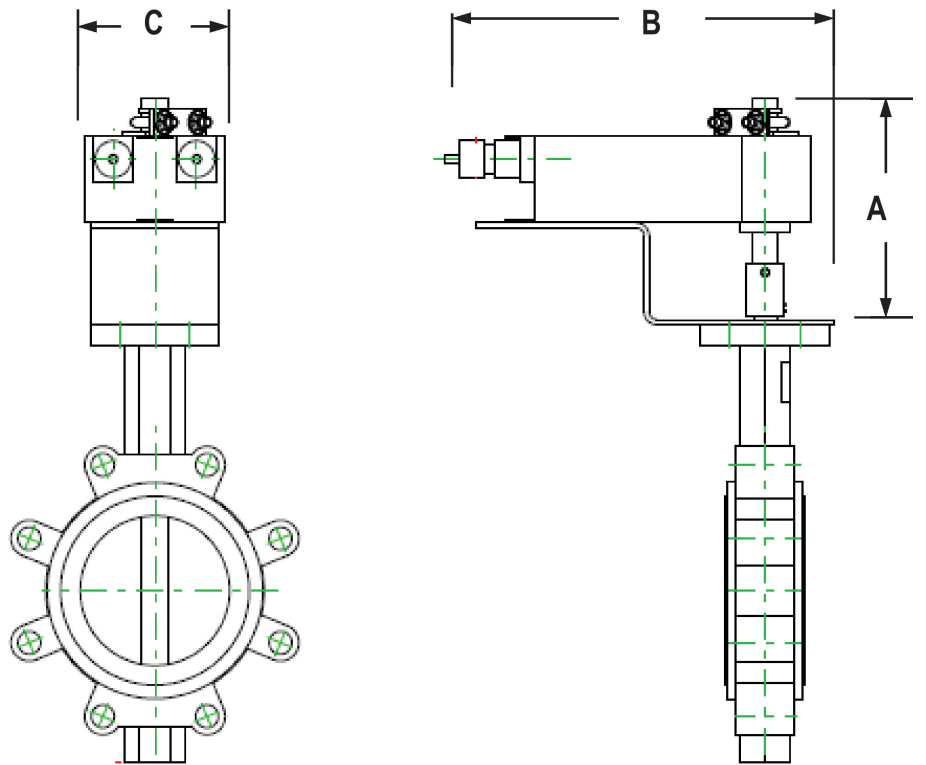

AFB, AFX

A	B	C
7.0" [178]	10.0" [254]	4.0" [101]