



2-year warranty

Type overview

Type	DN
B220VS	20

Technical data

Functional data	Valve size [mm]	0.75" [20]
	Fluid	chilled or hot water, up to 60% glycol, steam
	Fluid Temp Range (water)	-22...280°F [-30...138°C]
	Body Pressure Rating	600 psig WOG psi
	Close-off pressure Δps	600 psi
	Flow characteristic	modified equal percentage
	Max Differential Pressure (Steam)	35 psi
	Flow Pattern	2-way
	Leakage rate	ANSI Class VI
	Controllable flow range	90° rotation
	Cv	51
	Maximum Inlet Pressure (Steam)	35 psi [241 kPa]
	Maximum Velocity	15 FPS
Materials	Valve body	Bronze B584-C84400
	Housing seal	PTFE
	Stem	316 stainless steel
	Stem seal	RPTFE
	Seat	RPTFE
	Lock nut	stainless steel
	Pipe connection	NPT
	Retainer	B16 Brass
Ball	316 stainless steel	
Suitable actuators	Non-Spring	NMB(X) GRCB(X) GRB(X)
	Spring	NF

Safety notes



- **WARNING:** This product can expose you to lead which is known to the State of California to cause cancer and reproductive harm. For more information go to www.p65warnings.ca.gov

Product features

Application This valve is typically used in air handling units on heating or cooling coils, and fan coil unit heating or cooling coils. Some other common applications include Unit Ventilators, VAV Box re-heat coils and bypass loops. This valve is suitable for use in a hydronic system with variable flow. This valve is designed with MFT functionally which facilitates the use of various control input.

Up to 35 psi steam
 1/2" - 2" 600 PSIG WOG, Cold Non-Shock
 Federal Specification: WW-V-35C, Type II
 Composition: BZ
 Style: 3

Flow/Mounting details

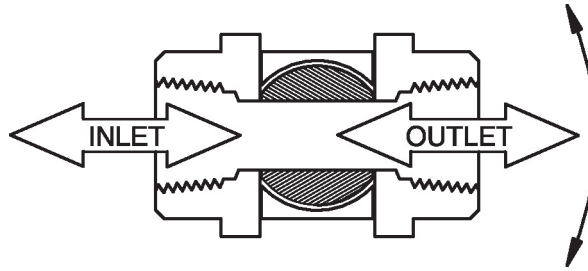

Dimensions

Type	DN	Weight
B220VS	20	1.76 lb [0.80 kg]

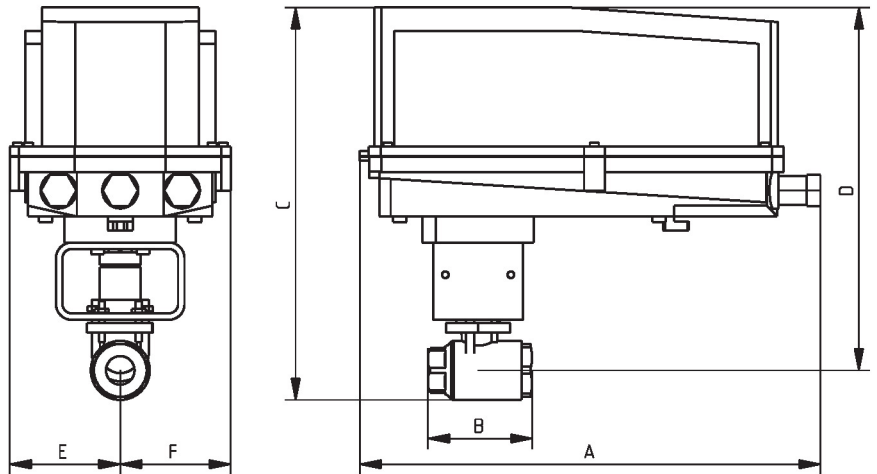

B220VS+GRC..N4

A	B	C	D	E	F
14.1" [358]	3.2" [82]	12.0" [305]	11.1" [282]	3.4" [86]	3.4" [86]