



5-year warranty



MFT

Technical data

| | | |
|------------------------|-------------------------------------|---------------------------------------------------------------------------------------------------|
| Electrical data | Nominal voltage | AC/DC 24 V |
| | Nominal voltage frequency | 50/60 Hz |
| | Nominal voltage range | AC 19.2...28.8 V / DC 21.6...28.8 V |
| | Power consumption in operation | 2.5 W |
| | Power consumption in rest position | 1 W |
| | Transformer sizing | 4 VA |
| | Auxiliary switch | 1 x SPDT, 3 A resistive (0.5 A inductive) @ AC 250 V, adjustable 0...95° |
| | Switching capacity auxiliary switch | 3 A resistive (0.5 A inductive) @ AC 250 V |
| | Electrical Connection | (2) 18 GA appliance cables, 1 m, with 1/2" conduit connectors |
| | Overload Protection | electronic throughout 0...95° rotation |
| Electrical Protection | actuators are double insulated | |
| Functional data | Torque motor | 22 in-lb [2.5 Nm] |
| | Operating range Y | 2...10 V |
| | Operating range Y note | 4...20 mA w/ ZG-R01 (500 Ω, 1/4 W resistor) |
| | Input Impedance | 100 kΩ for 2...10 V (0.1 mA), 500 Ω for 4...20 mA, 1500 Ω for PWM, On/Off and Floating point |
| | Operating range Y variable | Start point 0.5...30 V End point 2.5...32 V |
| | Operating modes optional | variable (VDC, PWM, on/off, floating point) |
| | Position feedback U | 2...10 V |
| | Position feedback U note | Max. 0.5 mA |
| | Position feedback U variable | VDC variable |
| | Direction of motion motor | selectable with switch 0/1 |
| | Direction of motion fail-safe | reversible with cw/ccw mounting |
| | Angle of rotation | Max. 95° |
| | Angle of rotation note | adjustable with mechanical stop |
| | Running Time (Motor) | 150 s / |
| | Running time motor variable | 75...300 s |
| | Running time fail-safe | <25 s @ -4...122°F [-20...50°C], <60 s @ -22°F [-30°C] |
| | Adaptation Setting Range | off (default) |
| | Override control | MIN (minimum position) = 0% MID (intermediate position) = 50% MAX (maximum position) = 100% |
| | Noise level, motor | 35 dB(A) |
| | Noise level, fail-safe | 62 dB(A) |
| Position indication | Mechanical | |
| Safety data | Power source UL | Class 2 Supply |

| | | |
|--------------------|------------------------------|---------------------------------------------------------------------------------------------|
| Safety data | Degree of protection IEC/EN | IP42 |
| | Degree of protection NEMA/UL | NEMA 2 |
| | Enclosure | UL Enclosure Type 2 |
| | Agency Listing | cULus acc. to UL60730-1A/-2-14, CAN/CSA E60730-1:02 CE acc. to 2014/30/EU and 2014/35/EU |
| | Quality Standard | ISO 9001 |
| | UL 2043 Compliant | Suitable for use in air plenums per Section 300.22(C) of the NEC and Section 602 of the IMC |
| | Ambient humidity | Max. 95% RH, non-condensing |
| | Ambient temperature | -22...122°F [-30...50°C] |
| | Storage temperature | -40...176°F [-40...80°C] |
| | Servicing | maintenance-free |
| Weight | Weight | 1.8 lb [0.83 kg] |
| Materials | Housing material | UL94-5VA |

Footnotes *Variable when configured with MFT options.

†Rated Impulse Voltage 800V, Type of Action 1.AA.B, Control Pollution Degree 3.

Product features

- Default/Configuration** Default parameters for DC 2...10 V applications of the TF.-MFT actuator are assigned during manufacturing. If required, custom versions of the actuator can be ordered. The parameters are variable and can be changed by three means: factory pre-set, custom configuration (set by the customer using PC-Tool software) or the handheld ZTH US.
- Application** For fail-safe, modulating control of dampers in HVAC systems. Actuator sizing should be done in accordance with the damper manufacturer's specifications. A feedback signal is provided for position indication.
- Operation** The TF series actuators provide true spring return operation for reliable fail-safe application and positive close-off on air tight dampers. The spring return system provides consistent torque to the damper with, and without, power applied to the actuator. The TF series provides 95° of rotation and is provided with a graduated position indicator showing 0 to 95°. The TF uses a brushless DC motor which is controlled by an Application Specific Integrated Circuit (ASIC) and a microprocessor. The microprocessor provides the intelligence to the ASIC to provide a constant rotation rate and to know the actuator's exact fail-safe position. The ASIC monitors and controls the brushless DC motor's rotation and provides a digital rotation sensing function to prevent damage to the actuator in a stall condition. The actuator may be stalled anywhere in its normal rotation without the need of mechanical end switches. Power consumption is reduced in holding mode. The TF -S versions are provided with one built-in auxiliary switch. This SPDT switch is provided for safety interfacing or signaling, for example, for fan start-up. The switching function is adjustable between 0° and 95°.
- Safety Note: Screw a conduit fitting into the actuator's bushing. Jacket the actuator's input and output wiring with suitable flexible conduit. Properly terminate the conduit in a suitable junction box.

Typical specification Spring return control damper actuators shall be direct coupled type which require no crank arm and linkage and be capable of direct mounting to a shaft up to a 1/2" diameter and center on a 1/2" shaft. The actuator must provide modulating damper control in response to a 2 to 10 VDC or, with the addition of a 500Ω resistor, a 4 to 20 mA control input from an electronic controller or positioner. The actuator must be designed so that they may be used for either clockwise or counter clockwise fail-safe operation. Actuators shall use a brushless DC motor controlled by a microprocessor and be protected from overload at all angles of rotation. Run time shall be constant, and independent of torque. A 2 to 10 VDC feedback signal shall be provided for position feedback. If required, one SPDT auxiliary switch shall be provided having the capability of being adjustable. Actuators with auxiliary switch must be constructed to meet the requirements for Double Insulation so an electrical ground is not required to meet agency listings. Actuators shall be cULus listed, have a 5 year warranty, and be manufactured under ISO 9001 International Quality Control Standards. Actuators shall be as manufactured by Belimo.

Factory settings Default parameters for DC 2...10 V applications of the TF..-MFT actuator are assigned during manufacturing. If required, custom versions of the actuator can be ordered. The parameters are variable and can be changed by three means: factory pre-set, custom configuration (set by the customer using PC-Tool software) or the handheld ZTH US.



Accessories

| Electrical accessories | Description | Type |
|------------------------|---------------------------------------------------------------------------------------------|----------|
| | DC Voltage Input Rescaling Module | IRM-100 |
| | Auxiliary switch, mercury-free | P475 |
| | Auxiliary switch, mercury-free | P475-1 |
| | Convert Pulse Width Modulated Signal to a 2...10 V Signal for Belimo Proportional Actuators | PTA-250 |
| | Positioner for wall mounting | SGA24 |
| | Positioner for front-panel mounting | SGF24 |
| | Cable conduit connector 1/2" | TF-CC US |
| | Gateway MP to BACnet MS/TP | UK24BAC |
| | Gateway MP to LonWorks | UK24LON |
| | Gateway MP to Modbus RTU | UK24MOD |
| | Resistor, 500 Ω, 1/4" wire resistor with 6" pigtail wires | ZG-R01 |
| | Resistor kit, 50% voltage divider | ZG-R02 |
| | Transformer, AC 120 V to AC 24 V, 40 VA | ZG-X40 |

| Mechanical accessories | Description | Type |
|------------------------|---------------------------------------------------------------------------------------------------------------------------------------|---------------|
| | Shaft extension 170 mm Ø10 mm for damper shaft Ø 6...16 mm | AV6-20 |
| | Position indicator for TFB(X) | IND-TF |
| | Shaft clamp for TFB(X) | K8 US |
| | Ball joint suitable for damper crank arm KH8 / KH10, Multipack 10 pcs. | KG10A |
| | Ball joint suitable for damper crank arm KH8, Multipack 10 pcs. | KG6 |
| | Ball joint suitable for damper crank arm KH8, Multipack 10 pcs. | KG8 |
| | Damper crank arm Slot width 8.2 mm, for Ø1.05" | KH12 |
| | Damper crank arm Slot width 6.2 mm, clamping range Ø10...18 mm | KH6 |
| | Damper crank arm Slot width 8.2 mm, clamping range Ø10...18 mm | KH8 |
| | TFB(X) crankarm with 5/16" slot. | KH-TF US |
| | TFB(X) crankarm with 1/4" slot. | KH-TF-1 US |
| | Screw fastening kit | SB-TF |
| | Push rod for KG10A ball joint 36" L, 3/8" diameter | SH10 |
| | Push rod for KG6 & KG8 ball joints (36" L, 5/16" diameter). | SH8 |
| | Anti-rotation bracket TF/NKQ/AM/NM/LM. | TF-P |
| | Wrench 0.32 in and 0.39 in [8 mm and 10 mm] | TOOL-06 |
| | Angle of rotation limiter, with end stop | ZDB-TF |
| | Mounting bracket for TFB(X) | ZG-113 |
| | Damper clip for damper blade, 3.5" width. | ZG-DC1 |
| | Damper clip for damper blade, 6" width. | ZG-DC2 |
| | Shaft extension for 3/8" diameter shafts (4" L). | ZG-LMSA-1 |
| | Shaft extension for 1/2" diameter shafts (5" L). | ZG-LMSA-1/2-5 |
| | TFB(X) crankarm adaptor kit (includes ZG-113). | ZG-TF112 |
| | TFB(X) crankarm adaptor kit (T bracket included). | ZG-TF2 |
| | Mounting kit for TFB(X) | ZG-TF3 |
| | Weather shield 330x203x152 mm [13x8x6"] (LxBxH) | ZS-100 |
| | Base plate, for ZS-100 | ZS-101 |
| | Weather shield 406x213x102 mm [16x8-3/8x4"] (LxWxH) | ZS-150 |
| Tools | Description | Type |
| | Connection cable 16 ft [5 m], A: RJ11 6/4 ZTH EU, B: free wire end for connection to MP/PP terminal | ZK2-GEN |
| | Service Tool, with ZIP-USB function, for programmable and communicative Belimo actuators, VAV controller and HVAC performance devices | ZTH US |
| | Belimo PC-Tool, Software for adjustments and diagnostics | MFT-P |
| | Signal simulator, Power supply AC 120 V | PS-100 |

Electrical installation

- ⚠ Warning! Live electrical components!**
During installation, testing, servicing and troubleshooting of this product, it may be necessary to work with live electrical components. Have a qualified licensed electrician or other individual who has been properly trained in handling live electrical components perform these tasks. Failure to follow all electrical safety precautions when exposed to live electrical components could result in death or serious injury.
- ◆ Meets cULus requirements without the need of an electrical ground connection.
 - ⚠ Apply only AC line voltage or only UL-Class 2 voltage to the terminals of auxiliary switches. Mixed or combined operation of line voltage/safety extra low voltage is not allowed.
 - Ⓐ Actuators with appliance cables are numbered.
 - 1 Provide overload protection and disconnect as required.
 - 3 Actuators may also be powered by DC 24 V.
 - 5 Only connect common to negative (-) leg of control circuits.
 - 7 A 500 Ω resistor (ZG-R01) converts the 4...20 mA control signal to 2...10 V.
 - 8 Control signal may be pulsed from either the Hot (Source) or Common (Sink) 24 V line.
 - 10 For triac sink the Common connection from the actuator must be connected to the Hot connection of the controller. Position feedback cannot be used with a triac sink controller; the actuator internal common reference is not compatible.

-  11 Actuators may be connected in parallel if not mechanically linked. Power consumption and input impedance must be observed.
-  12 IN4004 or IN4007 diode. (IN4007 supplied, Belimo part number 40155).
-  44 One built-in auxiliary switch (1x SPDT), for end position indication, interlock control, fan startup, etc.

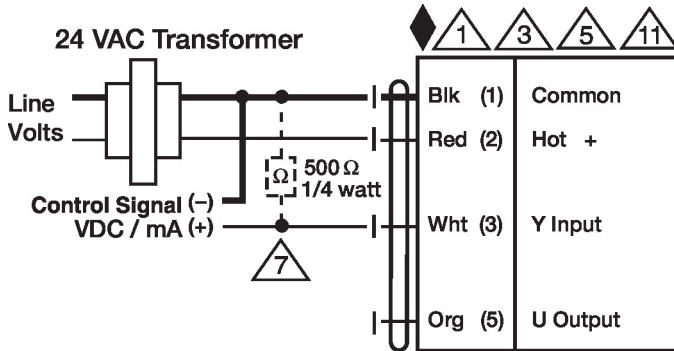

VDC/mA Control

Wiring diagrams

On/Off

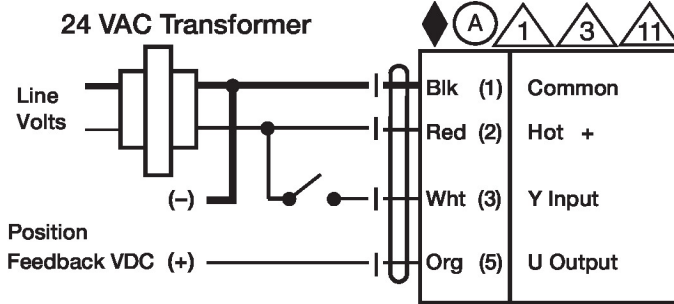

Floating Point

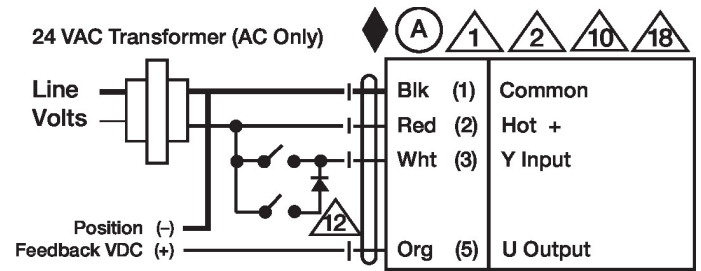

VDC/mA Control

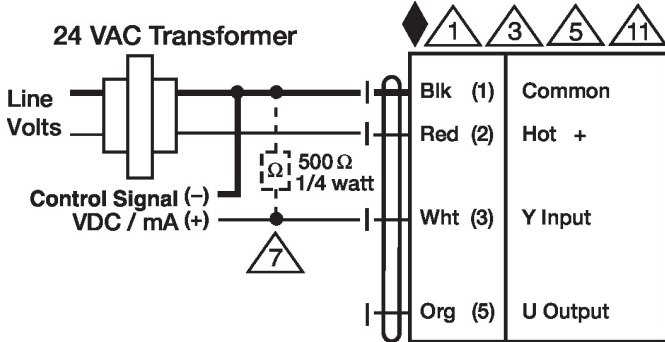

PWM Control

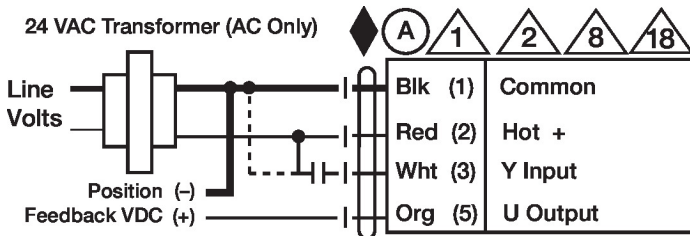

Override Control

24 VAC Transformer (AC Only)

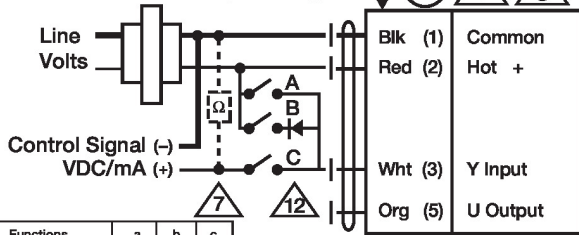

| Functions | a | b | c |
|-----------|------------------------|---|---|
| Min | 0% ← | ↗ | ↘ |
| Mid | 50% ← | ↗ | ↘ |
| Max | 100% ← | ↗ | ↘ |
| Normal | Control mode acc. to Y | ↗ | ↘ |

Auxiliary Switches

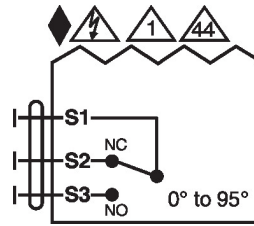

Dimensions

